

N-Channel Enhancement Mode Field Effect Transistor

Features

$V_{(BR)DSS}$	$R_{DS(ON)}$	I_D
250V	0.75Ω	6A

Application

- High efficiency switch mode power supplies
- Electronic lamp ballasts based on half bridge
- UPS

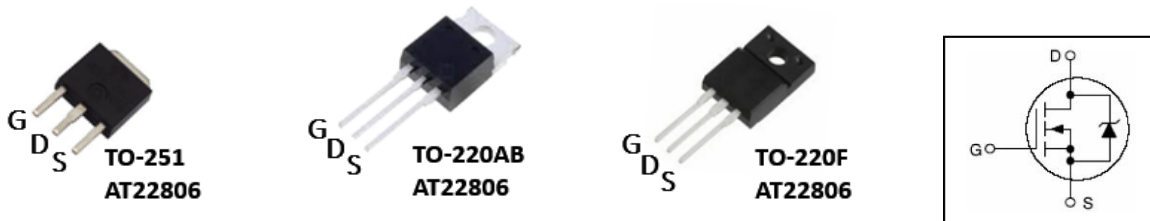

Order information:

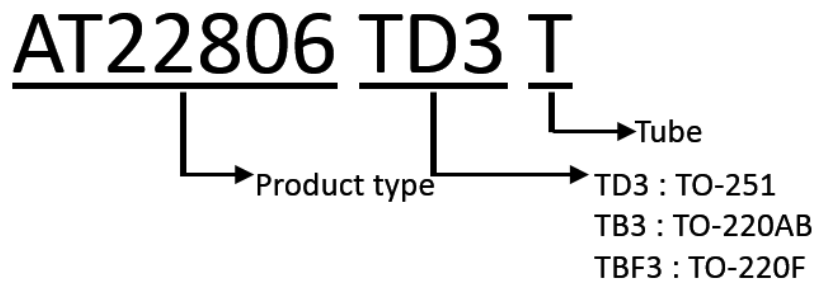

ABSOLUTE MAXIMUM RATINGS

PARAMETERS/TEST CONDITIONS	SYMBOL	LIMITS	UNITS
Drain-Source Voltage	V_{DS}	250	V
Drain Current –continuous @25°C	I_D	6	A
Drain Current –continuous @100°C	I_D	3.74	A
Pulsed Drain Current ¹	I_{DM}	24	A
Gate-Source Voltage	V_{GS}	±30	V
Single Pulse Avalanche ²	E_{AS}	180	mJ
Pulsed Avalanche Rating ²	I_{AS}	6	A
Operating Junction & Storage Temperature	T_j, T_{stg}	-55 to 150	°C
Lead Temperature (¹ / ₁₆ " from case for 10sec.)	T_L	300	°C

Note:

1. Pulse width limited by maximum junction temperature.
2. $V_{DD} = 50V, V_{DS} = 250V, R_G = 25 \Omega, T_J: 25^\circ C$

N-Channel Enhancement Mode Field Effect Transistor

ELECTRICAL CHARACTERISTICS

PARAMETER	SYMBOL	TEST CONDITIONS	LIMITS			UNIT
			MIN	TYP	MAX	
STATIC						
Drain-Source Breakdown Voltage	$V_{(BR)DSS}$	$V_{GS} = 0V, I_D = 250\mu A$	250			V
Gate Threshold Voltage	$V_{GS(th)}$	$V_{DS} = V_{GS}, I_D = 250\mu A$	3.0		4.5	
Gate-Body Leakage	I_{GSS}	$V_{DS} = 0V, V_{GS} = \pm 30V$			± 100	nA
Zero Gate Voltage Drain Current	I_{DSS}	$V_{DS} = 250V, V_{GS} = 0V$			1	μA
		$V_{DS} = 250V, V_{GS} = 0V, T_J = 150^\circ C$			10	
On-State Drain Current	$R_{DS(ON)}$	$V_{GS} = 10V, I_D = 3A$		0.75	0.9	Ω
Forward Transconductance	G_{FS}	$V_{DS} = 40V, I_D = 3A$		3.5		S
DYNAMIC						
Input Capacitance	C_{iss}	$V_{GS} = 0V, V_{DS} = 25V, f = 1MHz$		275		pF
Output Capacitance	C_{oss}			89		
Reverse Transfer Capacitance	C_{rss}			27		
Total Gate Charge	Q_g	$V_{DD} = 250V, I_D = 6A, V_{GS} = 10V$		16		nC
Gate-Source Charge	Q_{gs}			5.3		
Gate-Drain Charge	Q_{gd}			7.4		
SOURCE-DRAIN DIODE RATINGS AND CHARACTERISTICS ($T_C = 25^\circ C$)						
Continuous Current	I_S				6	A
Forward Voltage	V_{SD}	$I_F = I_S, V_{GS} = 0V$			1.5	V
Reverse Recovery Time	t_{rr}	$I_S = 6A, di_F/dt = 100A / \mu S$		155		nS
Reverse Recovery Charge	Q_{rr}	$V_{GS} = 0V$		780		nC
THERMAL DATA						
Thermal Resistance Junction to Case	$R_{\theta JC}$	AT22806 (TO-251)			3.5	$^\circ C/W$
		AT22806 (TO-220AB)			3.0	$^\circ C/W$
		AT22806 (TO-220F)			5.5	$^\circ C/W$
Thermal Resistance Junction to Ambient	$R_{\theta JA}$	AT22806 (TO-251)			100	$^\circ C/W$
		AT22806 (TO-220AB)			62.5	$^\circ C/W$
		AT22806 (TO-220F)			62.5	$^\circ C/W$

N-Channel Enhancement Mode Field Effect Transistor

Typical Characteristics

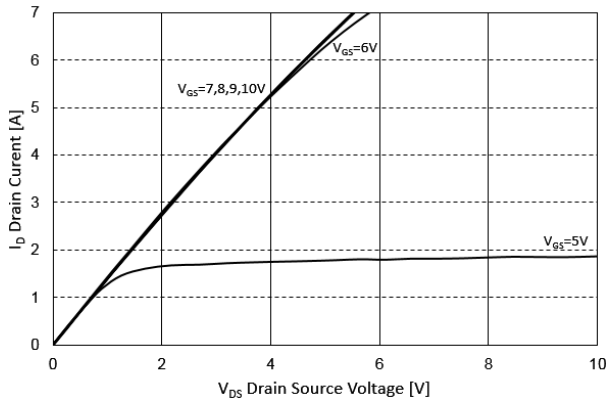

Figure 1. On-Region Characteristics

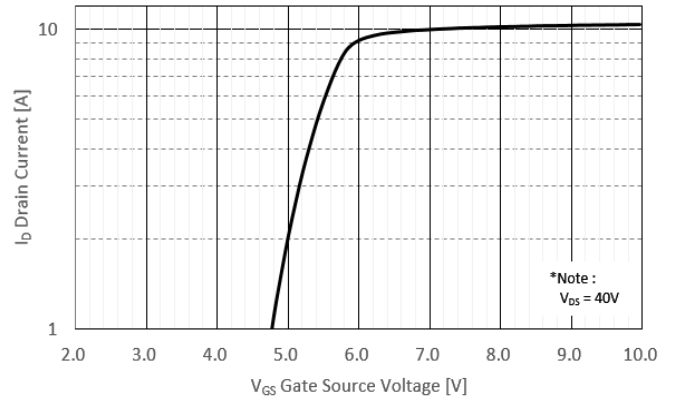

Figure 2. G_{FS} Characteristics

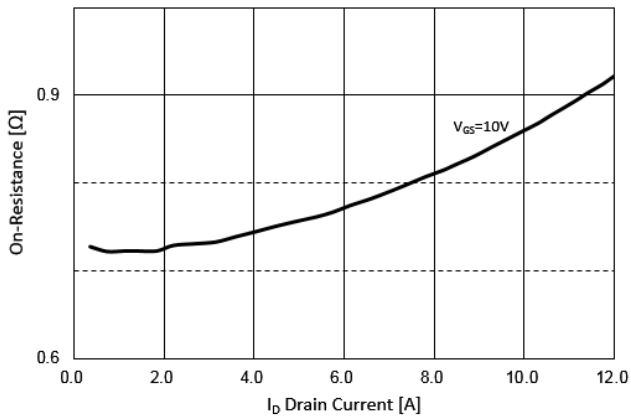

Figure 3. On-Resistance Variation vs Drain Current

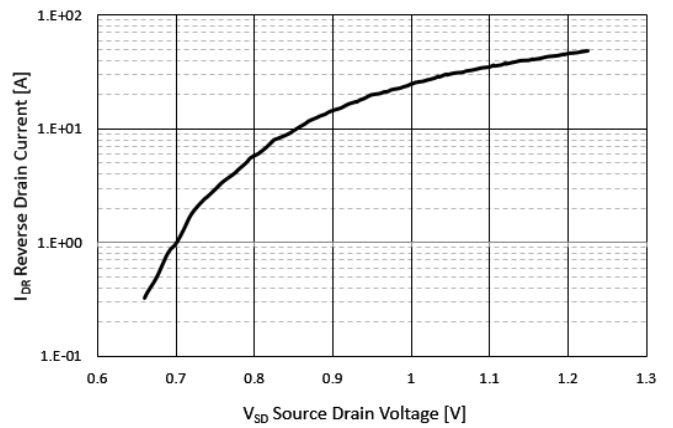

Figure 4. Body diode Forward Voltage

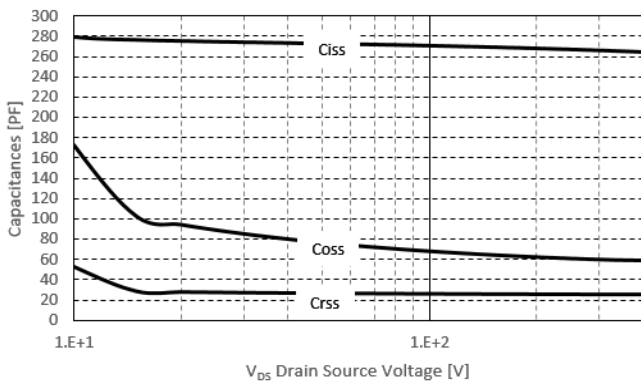

Figure 5. Capacitance Characteristics

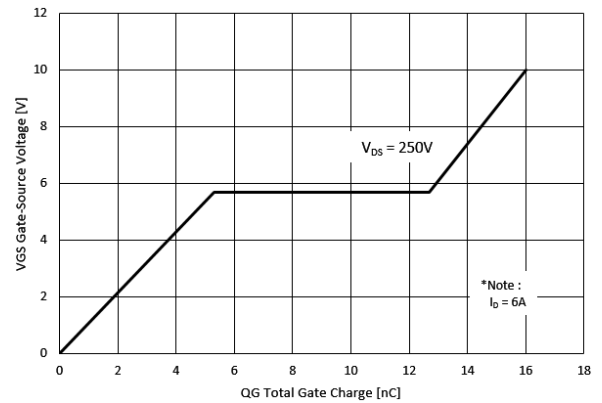
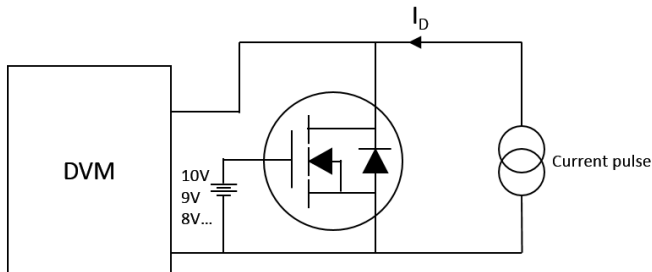

Figure 6. Gate Charge Characteristics

N-Channel Enhancement Mode Field Effect Transistor

On-Region Characteristics Test Circuit



V_{SD} Characteristics Test Circuit

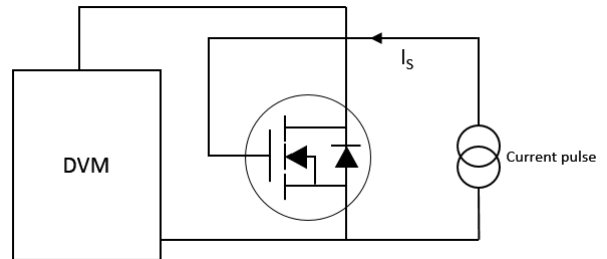

G_{FS} Characteristics Test Circuit

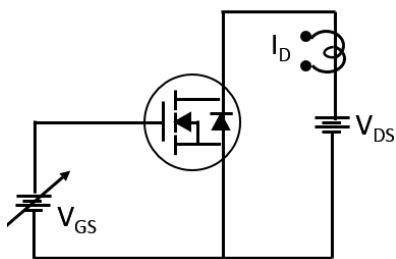

Input Capacitance Characteristics Test Circuit

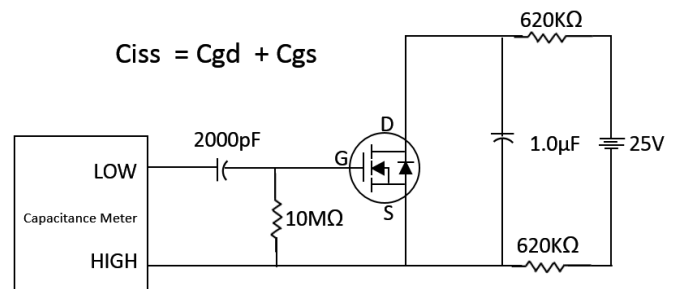

Output Capacitance Characteristics Test Circuit

$$C_{oss} = C_{gd} + C_{ds}$$

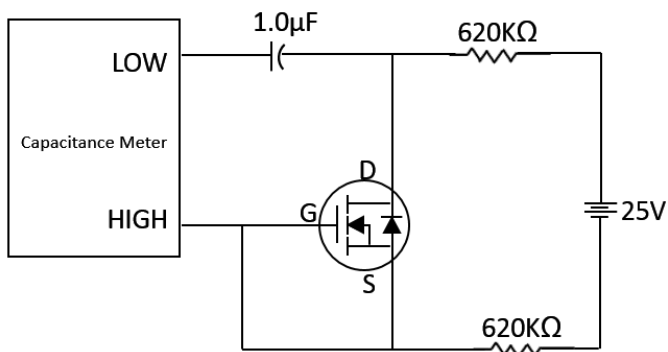

Reverse Capacitance Characteristics Test Circuit

$$C_{rss} = C_{gd}$$

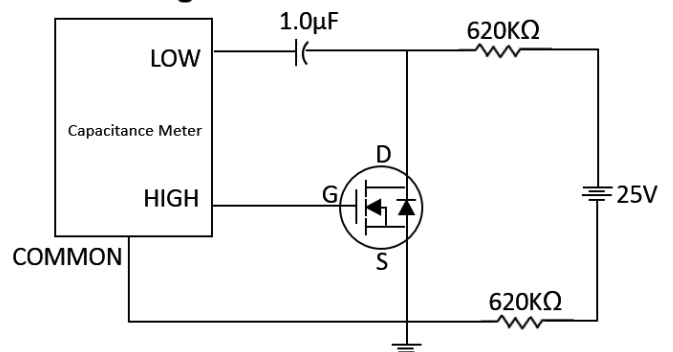

N-Channel Enhancement Mode Field Effect Transistor

Gate Charge Characteristics Test Circuit

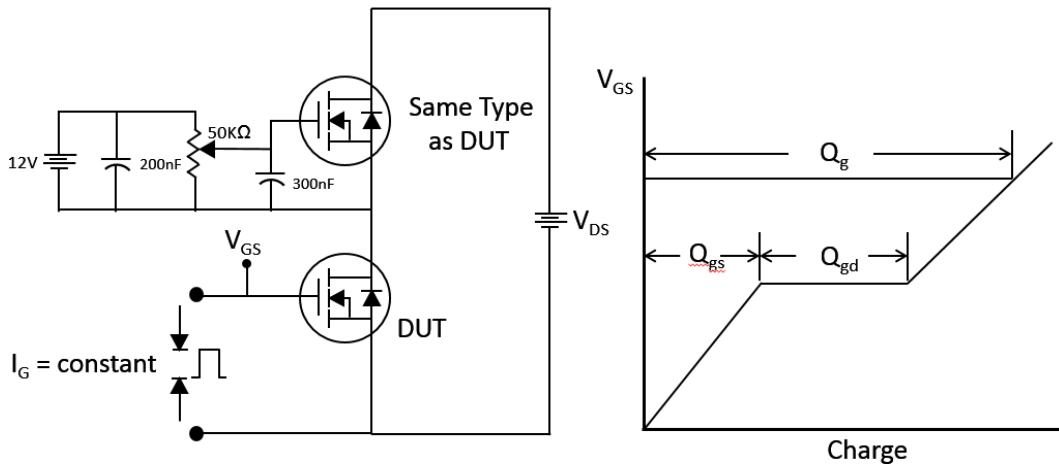

Avalanche Characteristics Test Circuit

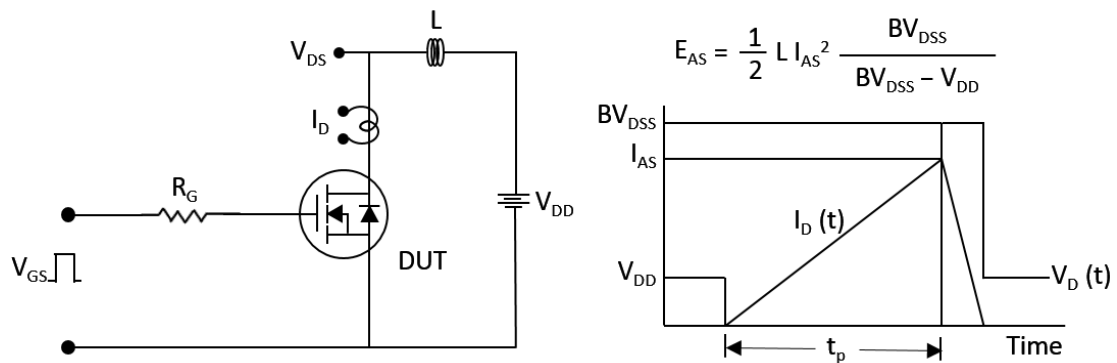

Diode Reverse recovery Characteristics Test Circuit

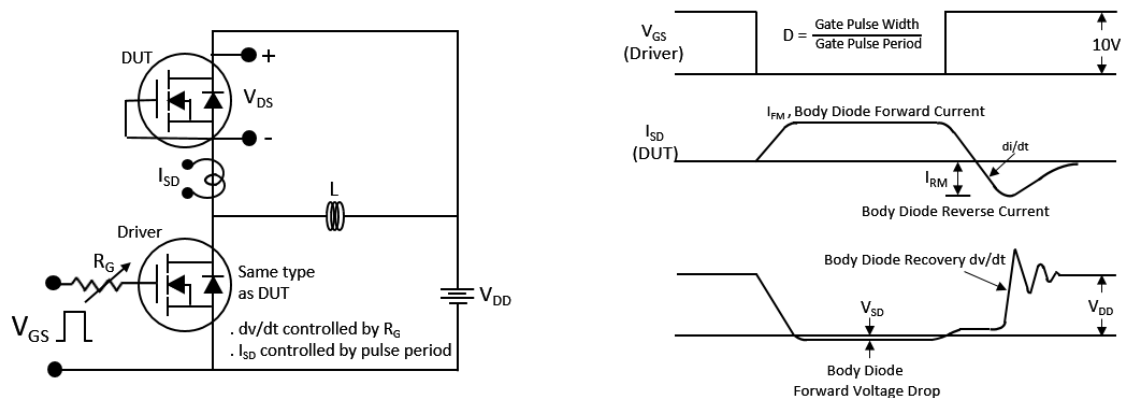

N-Channel Enhancement Mode Field Effect Transistor

Mechanical Dimensions

TO-251

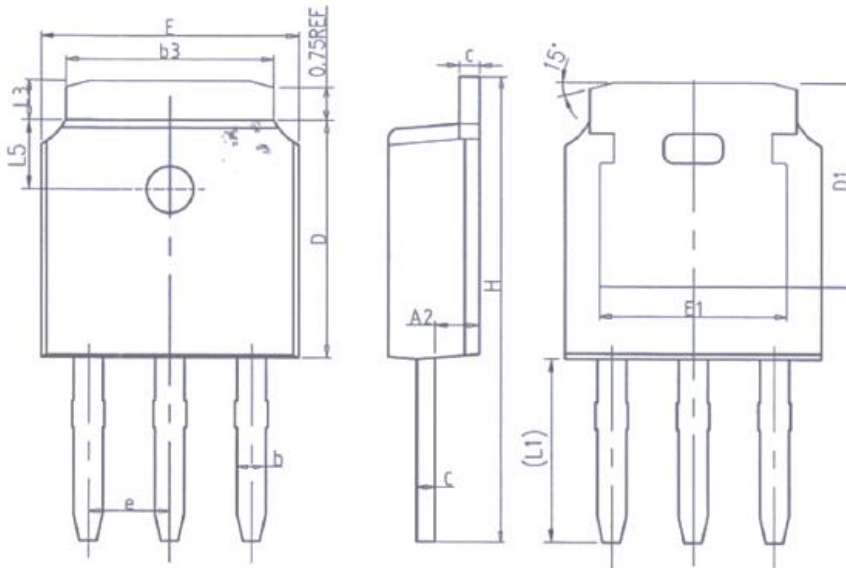

SYMBOL	MM		
	MIN	NOM	MAX
A	2.20	2.30	2.40
A2	0.97	1.07	1.17
b	0.68	0.78	0.90
b3	5.20	5.33	5.50
c	0.43	0.53	0.63
D	5.98	6.10	6.22
D1	5.30REF		
E	6.40	6.60	6.80
E1	4.63	-	-
e	2.286BSC		
H	10.00	11.22	11.44
L1	3.90	4.10	4.30
L3	0.88	1.02	1.28
L5	1.65	1.80	1.95

TO-220AB

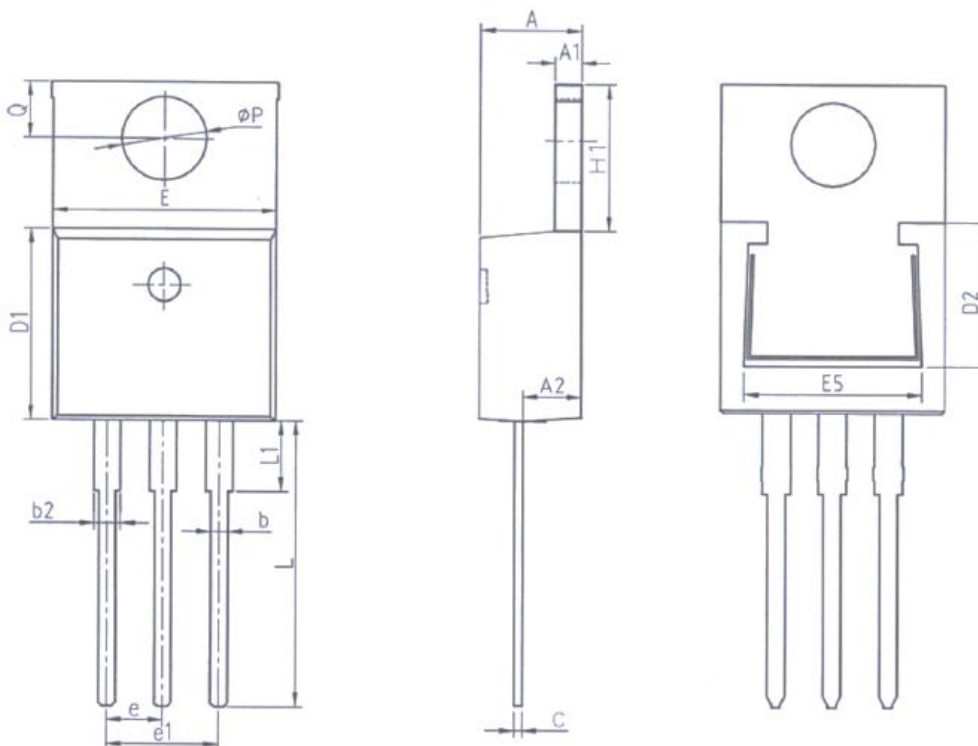

SYMBOL	MM		
	MIN	NOM	MAX
A	4.37	4.57	4.77
A1	1.22	1.27	1.42
A2	2.49	2.69	2.89
b	0.75	0.81	0.96
b2	1.22	1.27	1.47
c	0.30	0.38	0.48
D1	8.50	8.70	8.90
D2	5.20	-	-
E	9.86	10.16	10.36
E5	7.06	-	-
e	2.54 BSC		
e1	5.08 BSC		
H1	6.10	6.30	6.50
L	13.10	13.40	13.70
L1	-	3.75	4.10
ΦP	3.70	3.84	3.99
Q	2.54	2.74	2.94

N-Channel Enhancement Mode Field Effect Transistor

Mechanical Dimensions

TO-220F

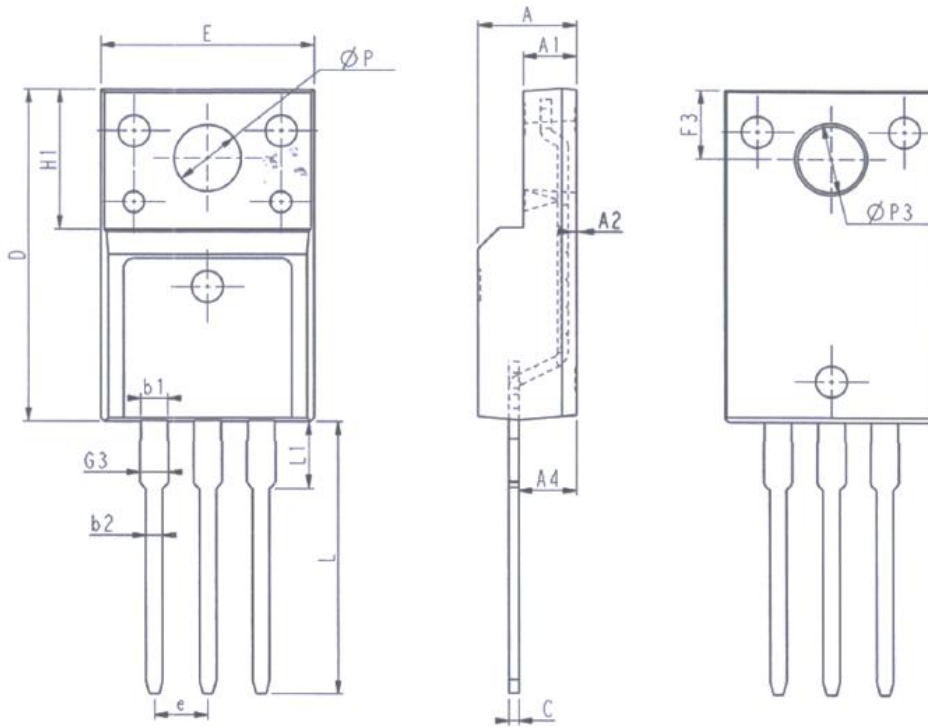

SYMBOL	MM		
	MIN	NOM	MAX
E	9.96	10.16	10.36
A	4.50	4.70	4.90
A1	2.34	2.54	2.74
A2	0.30	0.45	0.60
A4	2.56	2.76	2.96
c	0.40	0.50	0.65
D	15.57	15.87	16.17
H1	6.70REF		
e	2.54BSC		
L	12.68	12.98	13.28
L1	2.93	3.03	3.13
ØP	3.03	3.18	3.38
ØP3	3.15	3.45	3.65
F3	3.15	3.30	3.45
G3	1.25	1.35	1.55
b1	1.18	1.28	1.43
b2	0.70	0.80	0.95